

Infusion Disposables

Product Catalog



Gravity
Administration
Sets



Mangum™
Delivery Sets



Extension Sets

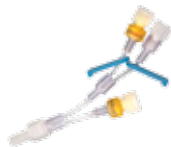

Filter Sets



Stopcocks and
Manifolds

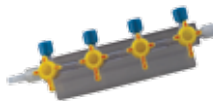

Components





Contents

Gravity Administration Sets	4
60 Drop	4
20 Drop	4
10 Drop	6
Secondary Sets	6
Mangum™ Delivery Sets	7
Extension Sets	9
Large Bore	9
Standard Bore	9
Small Bore	15
Small Bore Light Resistant Tubing	24
Small Bore T-Connectors	24
Micro Bore	27
Micro Bore Light Resistant Tubing	28
ULTRA™ Small Bore Extension Sets	29
Filter Sets	32
ULTRA™ Small Bore Filter Sets	32
Filter Sets	32
Stopcocks and Manifolds	34
Small Bore	34
Large Bore HI-FLO™ Stopcocks	35
Components	39
Check Valves	39
Connectors	39
Caps	40
1-Way Valve Medifolds	40
Injection Sites	41
Needle-Free Access Systems	42
Index	43

Gravity Administration Sets

ORDERING INFORMATION



60 Drop					
Product Code	Description	Features	Approx Priming Volume	Approx Overall Length	Units Per Case
SM872M 50351688500456	60 Drop Vented / Non-Vented Spike Gravity Administration Set with 15 Micron Filter, Roller Clamp, 2 Smart-Site® Needle-Free Valves, Swivel Luer Lock	• Non-DEHP formulation	17 mL	103" (262 cm)	25

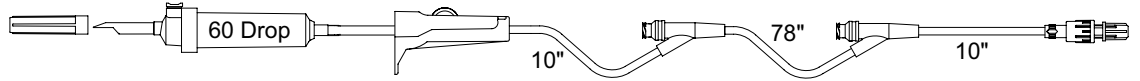

20 drop					
Product Code	Description	Features	Approx Priming Volume	Approx Overall Length	Units Per Case
MX7322SC 50351688505468	20 Drop Non-Vented Spike Gravity Administration Set with 2 "Y" Injection Site, Check Valve, Roller Clamp, Detachable 2-Gang HI-FLO™ 4-Way Stopcocks, Male Luer Lock and a 39" Extension, Pinch Clamp, Swivel Male Luer	• Non-DEHP formulation	15 mL	101" (257 cm)	25

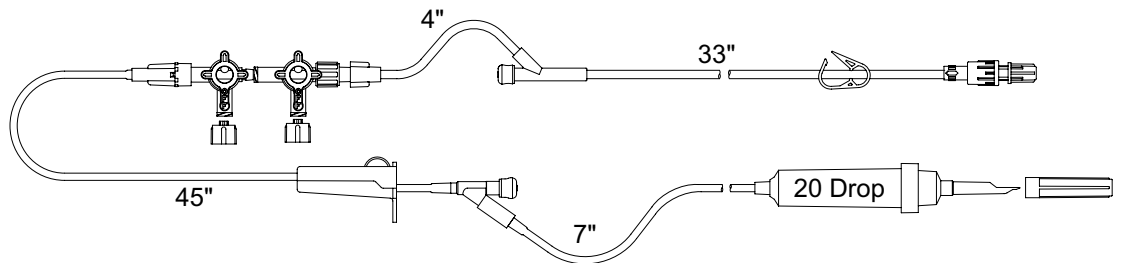

MX821L 50351688504928	20 Drop Non-Vented Spike Gravity Administration Set with 15 Micron Filter, Roller Clamp, Male Luer Lock	• Non-DEHP Formulation	12 mL	77" (196 cm)	25
--------------------------	---	------------------------	-------	--------------	----

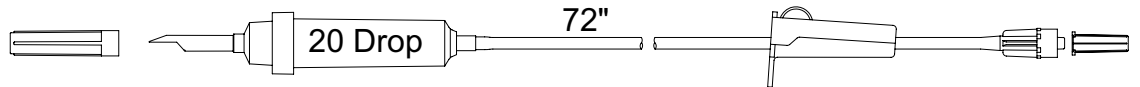

MX821S 50351688504911	20 Drop Non-Vented Spike Gravity Administration Set with 15 Micron Filter, Roller Clamp, Male Luer Lock	• Non-DEHP Fluid Path Formulation	10 mL	65" (165 cm)	25
--------------------------	---	-----------------------------------	-------	--------------	----

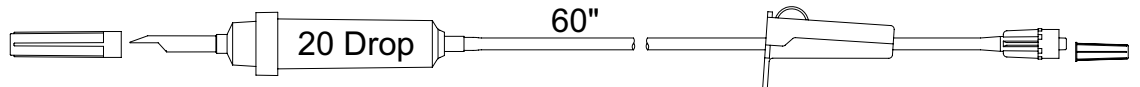

Please note: These products are not made with natural rubber latex.

ORDERING INFORMATION

20 drop					
Product Code	Description	Features	Approx Priming Volume	Approx Overall Length	Units Per Case
MX822S 50351688504874	20 Drop Bifurcated Non-Vented Spike Colored Coded Administration Set with 15 Micron Filter, Slide Clamp, Roller Clamps, Male Luer Locks	• Non-DEHP formulation	12 mL	65" (165 cm)	25

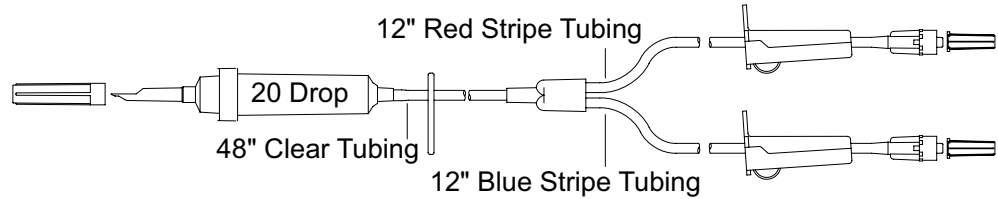

MX823S 50351688504867	20 Drop Trifurcated Non-Vented Spike Colored Coded Administration Set with 15 Micron Filter, Slide Clamp, Roller Clamps, Male Luer Locks	• Non-DEHP Formulation	15 mL	66" (168cm)	25
--------------------------	--	------------------------	-------	-------------	----

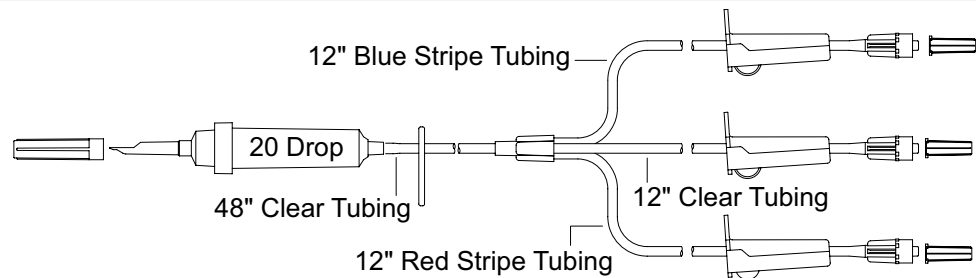

MX824 50351688504850	20 Drop Vented Spike Gravity Administration Set with 15 Micron Filter, Roller Clamp, Male Luer Lock	• Non-DEHP Formulation	18 mL	77" (196 cm)	25
-------------------------	---	------------------------	-------	--------------	----

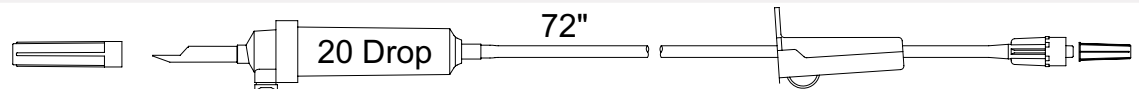

SM5009 50351688500593	20 Drop Vented / Non-Vented Spike Gravity Administration Set with 15 Micron Filter, 1 SmartSite® Needle-Free Valve, Swivel Male Luer Lock	• Non-DEHP Formulation	17 mL	100" (254 cm)	25
--------------------------	---	------------------------	-------	---------------	----

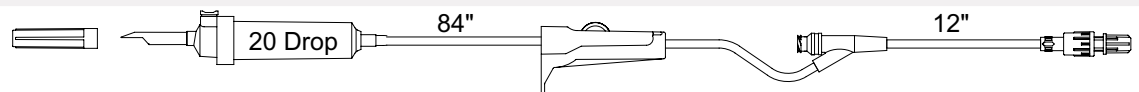

SM872 50351688500470	20 Drop Vented / Non-Vented Spike Gravity Administration Set with 15 Micron Filter, 2 SmartSite® Needle-Free Valves, Slide Swivel Luer Lock	• Non-DEHP Formulation	19 mL	103" (262 cm)	25
-------------------------	---	------------------------	-------	---------------	----

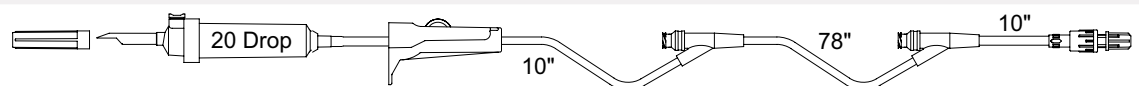

Please note: These products are not made with natural rubber latex.

ORDERING INFORMATION

20 drop					
Product Code	Description	Features	Approx Priming Volume	Approx Overall Length	Units Per Case
SM873 50351688500449	20 Drop Vented / Non-Vented Spike Gravity Administration Set with 15 Micron Filter, Back Check Valve, Roller Clamp, 3 SmartSite® Needle-Free Valves, Slide Swivel Luer Lock	• Non-DEHP Formulation	19 mL	106" (269 cm)	25

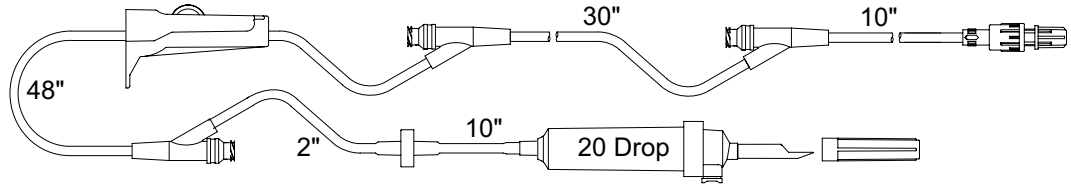

10 Drop					
Product Code	Description	Features	Approx Priming Volume	Approx Overall Length	Units Per Case
SM90976 50351688500418	10 Drop Vented / Non-Vented Spike Gravity Administration Set with Back Check Valve, 2 SmartSite® Needle-Free Valves, Roller Clamp, HI-FLO™ 4-Way Stopcock, 2-Gang Medifold with 1-Way Valves, Detachable Extension Set with Slide Clamp, Slide Swivel Luer Lock	• Non-DEHP formulation	24 mL	144" (366 cm)	25

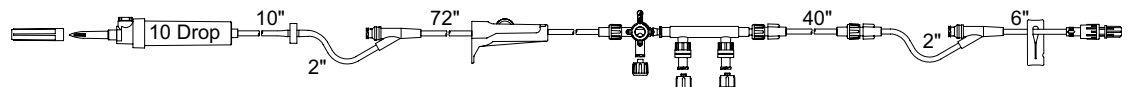

Secondary Sets					
Product Code	Description	Features	Approx Priming Volume	Approx Overall Length	Units Per Case
MX870 50351688505468	20 Drop Vented / Non-Vented with 15 Micron Filter, Secondary Administration Set with Roller Clamp, Swivel Luer Lock Includes Hanger	• Non-DEHP formulation	10 mL	35" (89 cm)	25

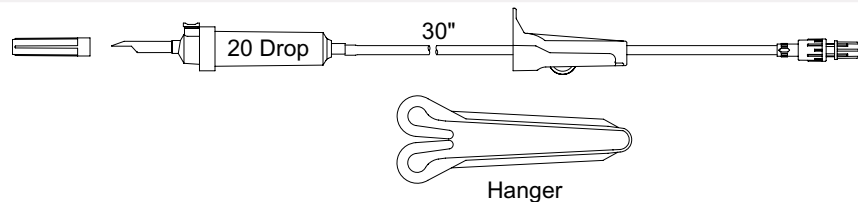

Please note: These products are not made with natural rubber latex.

Mangum™ Delivery Sets

ORDERING INFORMATION



10 Drop					
Product Code	Description	Features	Approx Priming Volume	Approx Overall Length	Units Per Case
MX448FMG 50351688507479	Vented / Non-Vented Spike Mangum™ Micro Delivery Administration Set, Pinch Clamp, Back Check Valve, Anti Free-Flow Stopcock, 6" Detachable Extension, 60" Small Bore Extension with 0.2 Micron Filter, Male Luer Lock	<ul style="list-style-type: none"> • Non-DEHP formulation • Air Eliminating filter 	3.0 mL	74" (188 cm)	25

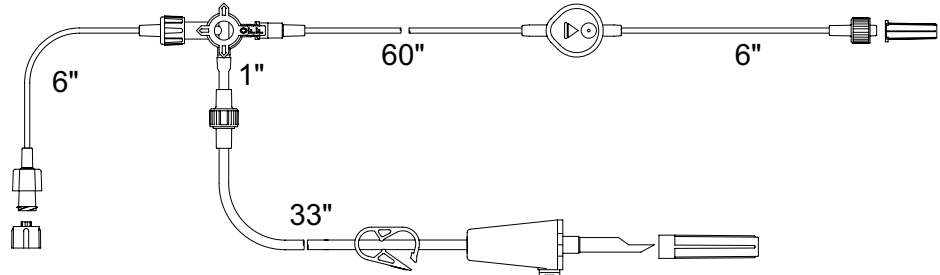

MX448HLMG 50351688507417	Vented / Non-Vented Spike Mangum™ Micro Delivery Administration Set, Pinch Clamp, Back Check Valve, Anti Free-Flow Stopcock, 6" Detachable Extension, 60" Small Bore Extension, Male Luer Lock	<ul style="list-style-type: none"> • Non-DEHP formulation • Non-PVC Fluid path 	2.5 mL	69" (175 cm)	25
-----------------------------	--	--	--------	--------------	----

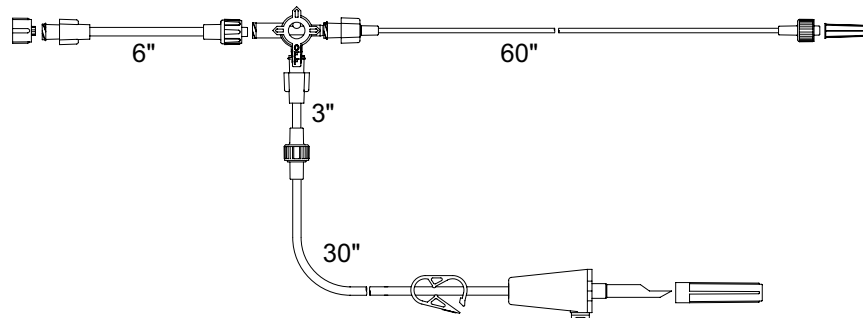

MX448L60MG 50351688507370	Vented / Non-Vented Spike Mangum™ Micro Delivery Administration Set, Pinch Clamp, Back Check Valve, Anti Free-Flow Stopcock, 6" Detachable Extension, 60" Small Bore Extension, Male Luer Lock	<ul style="list-style-type: none"> • Non-DEHP formulation 	2.6 mL	67" (170 cm)	25
------------------------------	--	--	--------	--------------	----

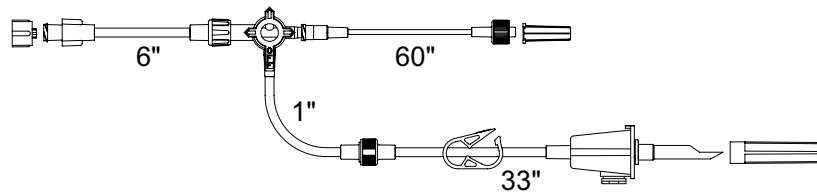

Please note: These products are not made with natural rubber latex.

ORDERING INFORMATION

Mangum™ Delivery Sets					
Product Code	Description	Features	Approx Priming Volume	Approx Overall Length	Units Per Case
MX5096020MG 50351688506830	Vented / Non-Vented Spike Mangum™ Micro Delivery Administration Set, Pinch Clamp, Back Check Valve, Small Body Anti Free-Flow Stopcock, 60" Micro Bore Extension, Male Luer Lock, For use with 1cc Syringes	<ul style="list-style-type: none"> • Non-DEHP formulation • Lipid Resistant 	0.5 mL	62" (157 cm)	25
MX536020MG 50351688506755	Vented / Non-Vented Spike Mangum™ Micro Delivery Administration Set, Pinch Clamp, Back Check Valve, Anti Free-Flow Stopcock, 6" Detachable Extension, 60" Micro Bore Extension, Male Luer Lock	<ul style="list-style-type: none"> • Non-DEHP Formulation 	1.3 mL	68" (173 cm)	25
MX536020MGIL 50351688506748	Vented / Non-Vented Spike Mangum™ Micro Delivery Administration Set, Pinch Clamp, Back Check Valve, Anti Free-Flow Stopcock, 60" Micro Bore Extension, Male Luer Lock	<ul style="list-style-type: none"> • Non-DEHP Formulation 	0.5 mL	60" (152 cm)	25
MX448F78M6	Small bore tubing, with 0.2 micron filter, bonded non-removable 6" (15cm) extension, anti free-flow stopcock	<ul style="list-style-type: none"> • Non-DEHP Formulation 	2.5 mL	87" (221cm)	25

Please note: These products are not made with natural rubber latex.

Extension Sets

ORDERING INFORMATION

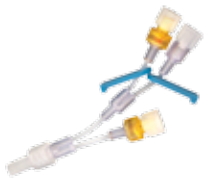

Large Bore					
Product Code	Description	Features	Approx Priming Volume	Approx Overall Length	Units Per Case
MX92133L 50351688504225	4-Way HI-FLO™ Stopcock, Large Bore Extension, Non-Vented Blue Cap on Middle Port, Male Luer Lock	<ul style="list-style-type: none"> Non-DEHP formulation 	7.0 mL	35" (89 cm)	50

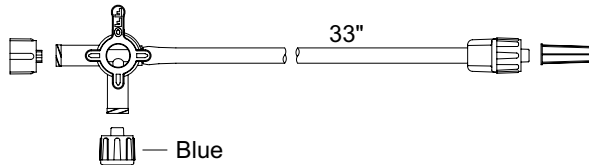

Standard Bore					
Product Code	Description	Features	Approx Priming Volume	Approx Overall Length	Units Per Case
MX048 50351688510301	Standard Bore Extension with Male Luer Lock	<ul style="list-style-type: none"> Non-DEHP formulation 	5 mL	49" (124 cm)	50

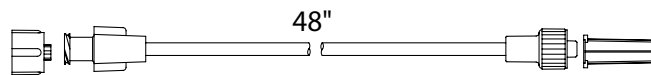

MX20307R1 50351688517799	4-way Large Bore HI-FLO™ Stopcock, Standard Bore Extension, SmartSite® Needle-free Valve, Slide Swivel Luer Lock	<ul style="list-style-type: none"> Non-DEHP Formulation 	3.8 mL	32" (81 cm)	25
-----------------------------	--	--	--------	-------------	----

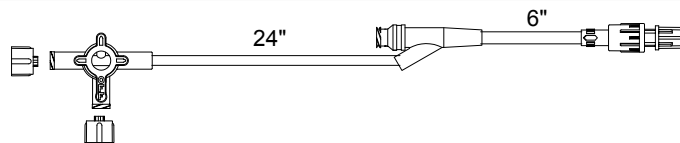

MX252L 50351688508230	3-Way Anesthesia Style Stopcock Standard Bore Extension with Injection Site, Non-Vented White Caps, Male Luer Lock	<ul style="list-style-type: none"> Non-DEHP Formulation Fluid Path 	2.4mL	22" (56 cm)	50
--------------------------	--	---	-------	-------------	----

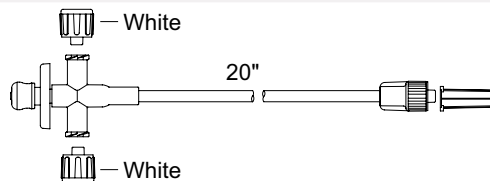

MX253L 50351688508223	3-Way Anesthesia Style Stopcock Standard Bore Extension with Injection Site, Non-Vented White Caps, Male Luer Lock	<ul style="list-style-type: none"> Non-DEHP Formulation Fluid Path 	3.9 mL	35" (89 cm)	50
--------------------------	--	---	--------	-------------	----

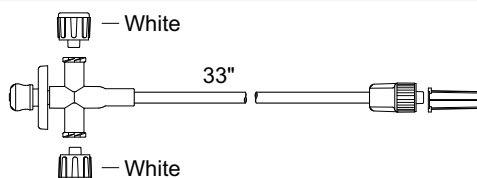

Please note: These products are not made with natural rubber latex.

ORDERING INFORMATION

Standard Bore						
Product Code	Description	Features	Approx Priming Volume	Approx Overall Length	Units Per Case	
MX254 50351688508216	3-Way Anesthesia Style Stopcock Standard Bore Extension with Injection Site, Non-Vented White Caps, Male Luer Lock	<ul style="list-style-type: none"> Non-DEHP Formulation Fluid Path 	4.6 mL	42" (107 cm)	50	
MX412SL 50351688507868	3-Way HI-FLO™ Stopcock Standard Bore Extension, Slide Swivel Luer Lock	<ul style="list-style-type: none"> Non-DEHP Formulation 	2.6 mL	22" (56 cm)	50	
MX413SL 50351688507820	3-Way HI-FLO™ Stopcock Standard Bore Extension, Slide Swivel Luer Lock	<ul style="list-style-type: none"> Non-DEHP Formulation 	4.1 mL	35" (89 cm)	50	
MX422SL 50351688507813	Large Bore 4-Way HI-FLO™ Stopcock Standard Bore Extension, Slide Swivel Luer Lock	<ul style="list-style-type: none"> Non-DEHP Formulation 	2.5 mL	22" (56 cm)	50	
MX4233NS 50351688507806	3-Gang Large Bore 4-Way HI-FLO™ Stopcocks Standard Bore Extension, Non-Vented White Caps, Non-Removable Blue Slide Clamp, Slide Swivel Luer Lock	<ul style="list-style-type: none"> Non-DEHP Formulation 	5.3 mL	44" (112 cm)	25	
MX423L 50351688507790	Large Bore 4-Way HI-FLO™ Stopcock Standard Bore Extension, Male Luer Lock	<ul style="list-style-type: none"> Non-DEHP Formulation 	3.8 mL	34" (86 cm)	50	

Please note: These products are not made with natural rubber latex.

ORDERING INFORMATION

Standard Bore					
Product Code	Description	Features	Approx Priming Volume	Approx Overall Length	Units Per Case
MX423YSL 50351688507783	Detachable Large Bore 4-Way HI-FLO™ Stopcock Standard Bore Extension with “Y” Injection Site, Slide Swivel Luer Lock	• Non-DEHP Formulation Fluid Path	5.0 mL	40" (102 cm)	50

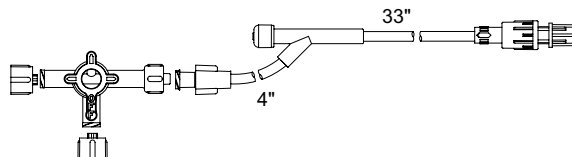

MX450SL 50351688507325	Standard Bore Extension with Slide Swivel Luer Lock	• Non-DEHP Formulation	2.4 mL	21" (53 cm)	50
---------------------------	---	------------------------	--------	-------------	----

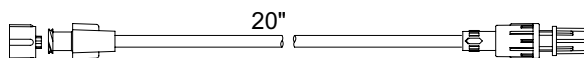

MX450FL 50351688507332	Standard Bore Extension with Male Luer Lock	• Non-DEHP Formulation	2.4 mL	21" (53 cm)	50
---------------------------	---	------------------------	--------	-------------	----



MX451SL 50351688507301	Standard Bore Extension with Slide Swivel Luer Lock	• Non-DEHP Formulation	4.2 mL	34" (86 cm)	50
---------------------------	---	------------------------	--------	-------------	----

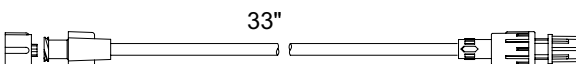

MX451FL 50351688507318	Standard Bore Extension with Male Luer Lock	• Non-DEHP Formulation	3.9 mL	34" (86 cm)	50
---------------------------	---	------------------------	--------	-------------	----

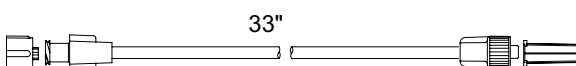

MX452 50351688507288	Standard Bore Extension with Pinch Clamp, Male Luer Lock	• Non-DEHP Formulation	0.8 mL	7" (18 cm)	50
-------------------------	--	------------------------	--------	------------	----



MX452FL 50351688507271	Standard Bore Extension with Male Luer Lock	• Non-DEHP Formulation	0.8 mL	7" (18 cm)	50
---------------------------	---	------------------------	--------	------------	----

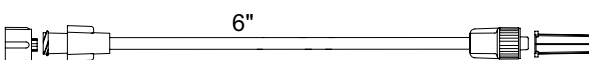

MX454FL 50351688507165	Standard Bore Extension with Removable Slide Clamp with Male Luer Lock	• Non-DEHP Formulation	2.3 mL	21" (53 cm)	50
---------------------------	--	------------------------	--------	-------------	----

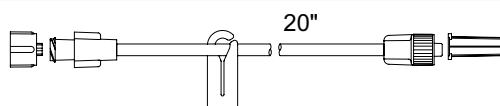

Please note: These products are not made with natural rubber latex.

ORDERING INFORMATION

Standard Bore					
Product Code	Description	Features	Approx Priming Volume	Approx Overall Length	Units Per Case
MX455FL 50351688507158	Standard Bore Extension with Removable Slide Clamp, Male Luer Lock	<ul style="list-style-type: none"> • Non-DEHP Formulation 	4.0 mL	34" (86 cm)	50

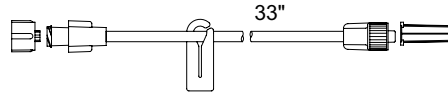

MX456CVL 50351688507134	Standard Bore Bifurcated Extension with 2 Back Check Valves, Male Luer Lock	<ul style="list-style-type: none"> • Non-DEHP Formulation 	1.0 mL	5" (13 cm)	50
----------------------------	---	--	--------	------------	----

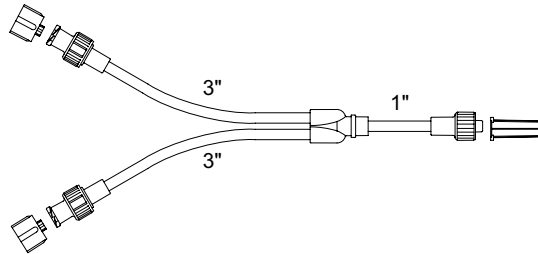

MX456R 50351688507110	Standard Bore Bifurcated Extension, Non-Vented Blue Caps with Rotating Male Luer Lock	<ul style="list-style-type: none"> • Non-DEHP Formulation 	0.6 mL	3" (8 cm)	50
--------------------------	---	--	--------	-----------	----

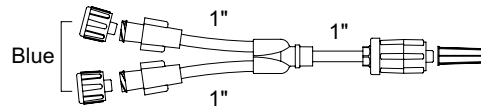

MX456L 50351688507127	Standard Bore Bifurcated Extension, Non-Vented Blue Caps, Male Luer Lock	<ul style="list-style-type: none"> • Non-DEHP Formulation 	0.6 mL	3" (8 cm)	50
--------------------------	--	--	--------	-----------	----

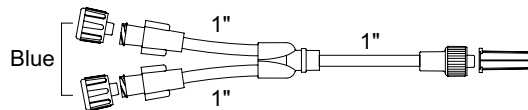

MX458L 50351688507073	Standard Bore Color-Coded Trifurcated Extension with Pinch Clamps, Non-Vented Blue Caps, Male Luer Lock	<ul style="list-style-type: none"> • DEHP Formulation 	1.8 mL	6" (15.2 cm)	50
--------------------------	---	--	--------	--------------	----

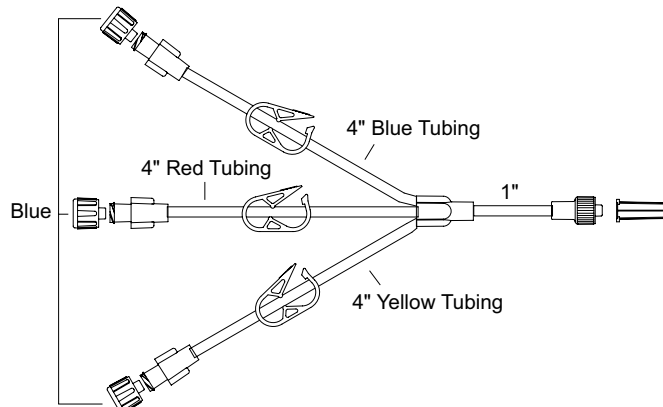

Please note: These products are not made with natural rubber latex.

ORDERING INFORMATION

Standard Bore					
Product Code	Description	Features	Approx Priming Volume	Approx Overall Length	Units Per Case
MX522L 50351688506823	Small Bore 4-Way Stopcock Standard Bore Extension with Male Luer Lock	• Non-DEHP Formulation	2.5 mL	22" (56 cm)	50

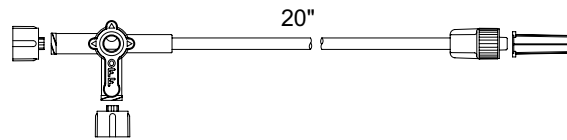

MX522SL 50351688506816	Small Bore 4-Way Stopcock Standard Bore Extension, Non-Vented Blue Cap on Middle Port, Slide Swivel Male Luer Lock	• Non-DEHP Formulation	2.5 mL	22" (56 cm)	50
---------------------------	--	------------------------	--------	-------------	----

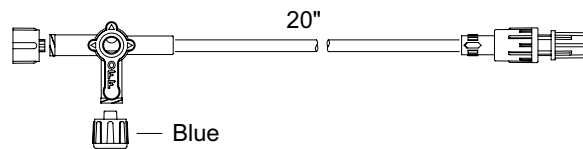

MX7222SC 50351688505543	2-Gang Large Bore 4-Way HI-FLO™ Stopcocks, Detachable Standard Bore Extension with "Y" Injection Site, Pinch Clamp, Slide Swivel Male Luer Lock	• Non-DEHP Fluid Path Formulation	5.2 mL	40" (102 cm)	25
----------------------------	---	-----------------------------------	--------	--------------	----

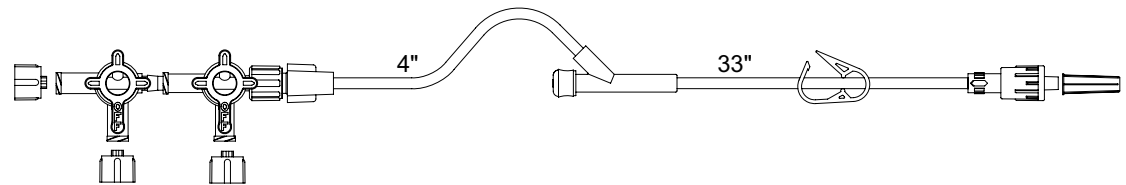

MX7223SC 50351688507127	3-Gang Large Bore 4-Way HI-FLO™ Manifold, Non-Vented Blue Caps on Middle Ports, Detachable Standard Bore Extension with "Y" Injection Site, Pinch Clamp, Slide Swivel Male Luer Lock	• Non-DEHP Fluid Path Formulation	5.5 mL	42" (107 cm)	25
----------------------------	--	-----------------------------------	--------	--------------	----

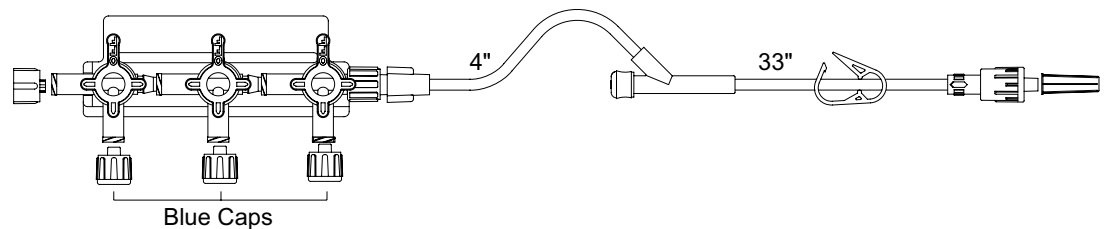

SM5006 50351688500623	Standard Bore Extension with 2 SmartSite® Needle-Free Valves, Pinch Clamp, Slide Swivel Luer Lock	• Non-DEHP Formulation	1.6 mL	13" (33 cm)	50
--------------------------	---	------------------------	--------	-------------	----

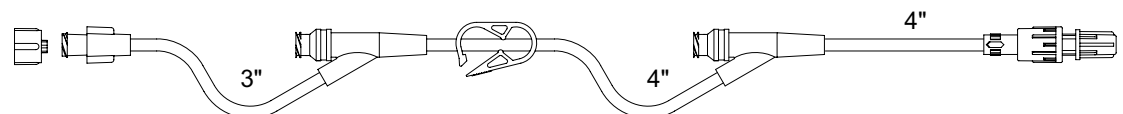

Please note: These products are not made with natural rubber latex.

ORDERING INFORMATION

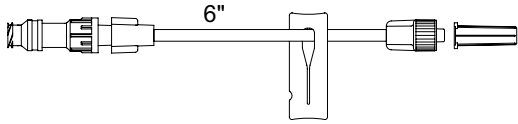
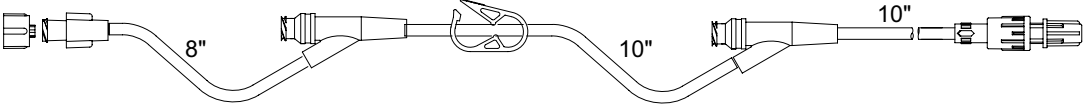
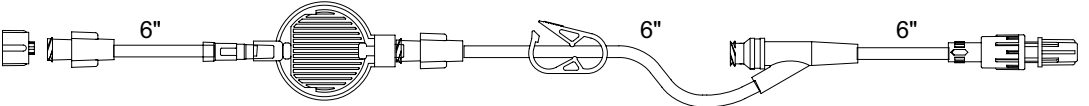
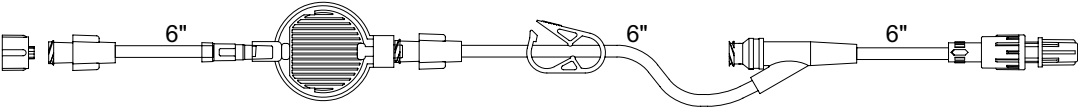
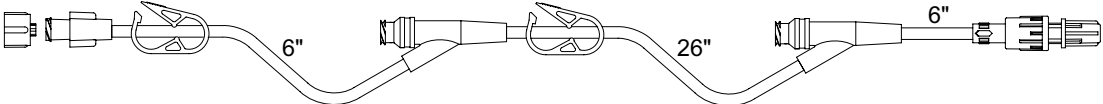
Standard Bore					
Product Code	Description	Features	Approx Priming Volume	Approx Overall Length	Units Per Case
SM5010 50351688500586	Standard Bore Extension, Pinch Clamp, SmartSite® Needle-Free Valve, Slide Swivel Luer Lock	<ul style="list-style-type: none"> • Non-DEHP Formulation 	3.0 mL	22" (56 cm)	50
					
SM5011 50351688500579	Standard Bore Extension with SmartSite® Needle-Free Valve, Non-Removable Blue Slide Clamp, Male Luer Lock	<ul style="list-style-type: none"> • Non-DEHP Formulation 	0.8 mL	8" (20 cm)	100
					
SM5012 50351688500562	Standard Bore Extension with 2 SmartSite® Needle-Free Valves, Pinch Clamp, Slide Swivel Luer Lock	<ul style="list-style-type: none"> • Non-DEHP Formulation 	4.0 mL	30" (76 cm)	50
					
SM5020 50351688500548	Standard Bore Extension with 0.2 Micron Filter, Pinch Clamp, SmartSite® Needle-Free Valve, Slide Swivel Luer Lock	<ul style="list-style-type: none"> • Non-DEHP Formulation • Low Protein Binding Filter 	3.1 mL	20" (51 cm)	25
					
SM5021 50351688500531	Standard Bore Extension with 1.2 Micron Filter, Pinch Clamp, SmartSite® Needle-Free Valve, Slide Swivel Luer Lock	<ul style="list-style-type: none"> • Non-DEHP Formulation • Low Protein Binding Filter 	3.0 mL	20" (51 cm)	25
					
SM5024 50351688500524	Standard Bore Extension with Pinch Clamps, 2 SmartSite® Needle-Free Valves, Slide Swivel Luer Lock	<ul style="list-style-type: none"> • Non-DEHP Formulation 	4.7 mL	40" (102 cm)	25
					

Please note: These products are not made with natural rubber latex.

ORDERING INFORMATION

Standard Bore					
Product Code	Description	Features	Approx Priming Volume	Approx Overall Length	Units Per Case
SM7223SC 50351688500487	3-Gang Large Bore 4-Way HI-FLO™ Manifold with Non-Vented Blue Caps on Middle Ports, Detachable Standard Bore Extension, SmartSite® Needle-Free Valve, Pinch Clamp, Slide Swivel Male Luer Lock	• Non-DEHP Formulation	5.6 mL	42" (107 cm)	25

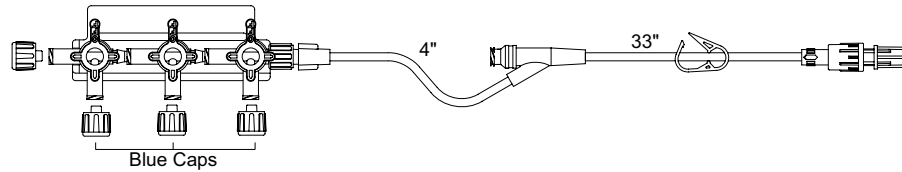

SM924SL 50351688500401	4-Way Large Bore HI-FLO™ Stopcock with Non-Vented Blue Cap on Middle Port, Standard Bore Extension, SmartSite® Needle-Free Valve, Slide Swivel Luer Lock	• Non-DEHP Formulation	4.6 mL	39" (99 cm)	50
---------------------------	--	------------------------	--------	-------------	----

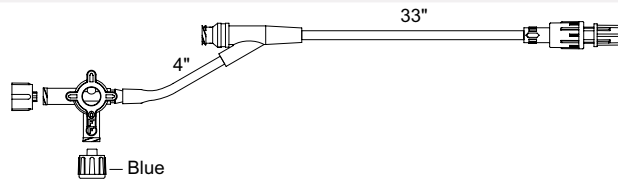

Small Bore					
Product Code	Description	Features	Approx Priming Volume	Approx Overall Length	Units Per Case
53035 50351688516464	Small Bore Extension with Non-Removable Blue Slide Clamp, Male Luer Lock	• Non-DEHP Formulation	0.2 mL	5" (13 cm)	50

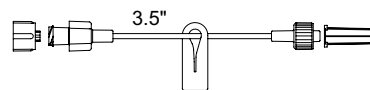

5360225 50351688516372	Small Bore Extension with Male Luer Lock	• DEHP Formulation	2.4 mL	60" (152 cm)	25
---------------------------	--	--------------------	--------	--------------	----

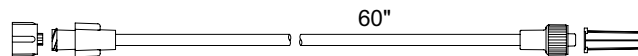

5360225C 50351688516365	Small Bore Extension with Pinch Clamp, Male Luer Lock	• DEHP Formulation	2.4 mL	60" (152 cm)	25
----------------------------	---	--------------------	--------	--------------	----

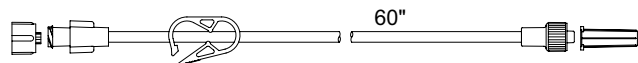

536035 50351688516358	Small Bore Extension with Non-Removable Blue Slide Clamp, Male Luer Lock	• Non-DEHP Formulation	1.1 mL	61" (155 cm)	50
--------------------------	--	------------------------	--------	--------------	----

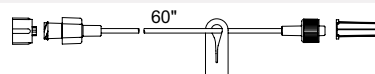

Please note: These products are not made with natural rubber latex.

ORDERING INFORMATION

Small Bore					
Product Code	Description	Features	Approx Priming Volume	Approx Overall Length	Units Per Case
536035SC 50351688516341	Small Bore 3-Way Stopcock Extension with Male Luer Lock	<ul style="list-style-type: none"> Non-DEHP Formulation 	1.3 mL	63" (160 cm)	25
537235C 50351688516297	Small Bore Extension with Non-Removable Blue Slide Clamp, Male Luer Lock	<ul style="list-style-type: none"> Non-DEHP Formulation 	1.3 mL	72" (183 cm)	50
539635 50351688516266	Small Bore Extension with Non-Removable Blue Slide Clamp, Male Luer Lock	<ul style="list-style-type: none"> Non-DEHP Formulation 	1.6 mL	96" (244 cm)	50
BF100 50351688511988	Small Bore Bifurcated Extension with Color-Coded Pinch Clamps, 1 Non-Vented White Cap, Male Luer Lock	<ul style="list-style-type: none"> DEHP Formulation 	0.6 mL	7" (18 cm)	25
BF13 50351688511971	Small Bore Bifurcated Extension with Color-Coded Pinch Clamps, 1 Back Check Valve, Male Luer Lock	<ul style="list-style-type: none"> DEHP Formulation 	0.6 mL	7" (18 cm)	25
BTF36 50351688511605	Small Bore Trifurcated Extension with 2 Back Check Valves, Non-Removable Blue Slide Clamps, Swivel Male Luer Lock	<ul style="list-style-type: none"> Non-DEHP Formulation 	0.4 mL	4" (10 cm)	25

Please note: These products are not made with natural rubber latex.

ORDERING INFORMATION

Small Bore					
Product Code	Description	Features	Approx Priming Volume	Approx Overall Length	Units Per Case
FS113 50351688510981	Small Bore Trifurcated Extension with 0.2 Micron Filter, Color-Coded Non-Removable Slide Clamps, Male Luer Lock	<ul style="list-style-type: none"> • Non-DEHP Formulation • Low Protein Binding Filter 	0.9 mL	13" (33 cm)	25

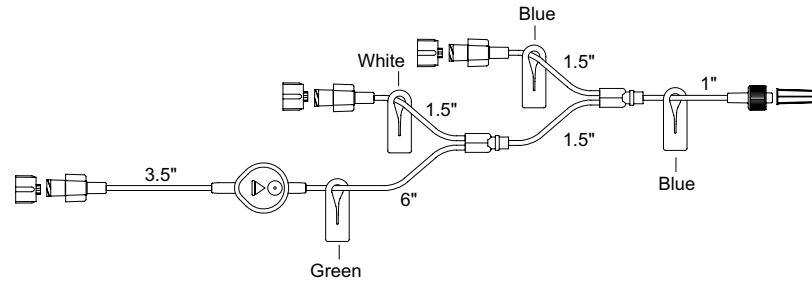

MBF27 50351688510479	Small Bore Extension with Non-Removable Blue Slide Clamps, 1 Non-Vented White Cap, Swivel Male Luer Lock	<ul style="list-style-type: none"> • Non-DEHP Formulation 	0.4 mL	5" (13 cm)	25
-------------------------	--	--	--------	------------	----

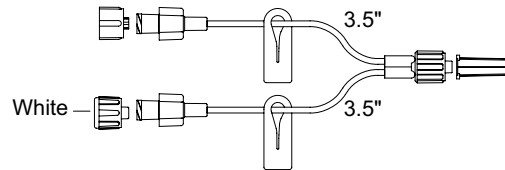

MBF30 50351688510448	Small Bore Bifurcated Extension with Non-Removable Blue Slide Clamps, 1 Non-Vented White Cap, Male Luer Lock	<ul style="list-style-type: none"> • Non-DEHP Formulation 	0.4 mL	6" (15 cm)	25
-------------------------	--	--	--------	------------	----

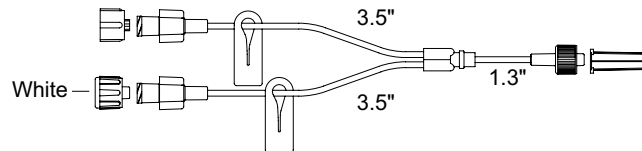

MTF37 50351688510325	Small Bore Trifurcated Extension with Non-Removable Blue Slide Clamps, 2 Non-Vented White Caps, Swivel Male Luer Lock	<ul style="list-style-type: none"> • Non-DEHP Formulation 	0.5 mL	4" (10 cm)	25
-------------------------	---	--	--------	------------	----

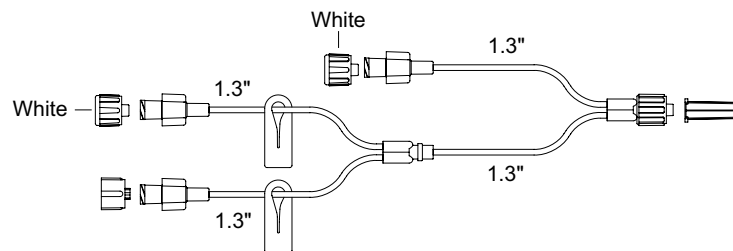

MX20194 50351688509688	Small Bore Extension with Pinch Clamp, Male Luer Lock	<ul style="list-style-type: none"> • Non-DEHP Formulation 	6.5 mL	240" (609 cm)	25
---------------------------	---	--	--------	---------------	----



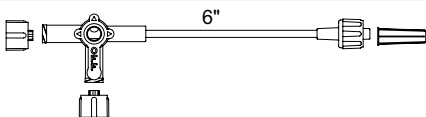
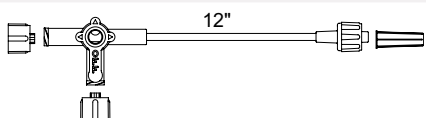
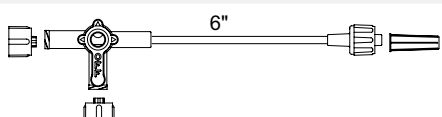
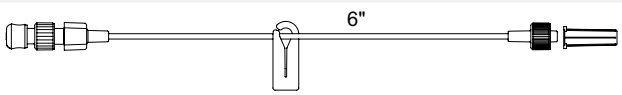
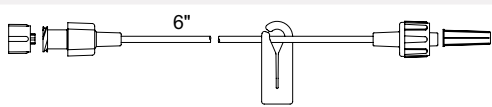
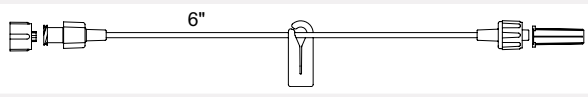
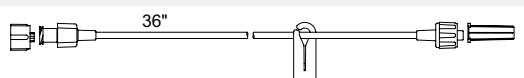

Please note: These products are not made with natural rubber latex.

ORDERING INFORMATION

Small Bore						
Product Code	Description	Features	Approx Priming Volume	Approx Overall Length	Units Per Case	
MX43660 50351688507561	Small Bore 3-Way Stopcock Extension, Male Luer Lock	<ul style="list-style-type: none"> • Non-DEHP Formulation 	0.4 mL	8" (20 cm)	25	
MX43661 50351688507554	Small Bore 3-Way Stopcock Extension, Male Luer Lock	<ul style="list-style-type: none"> • Non-DEHP Formulation 	0.5 mL	14" (36 cm)	25	
MX43860 50351688507530	Small Bore 4-Way Stopcock Extension, Male Luer Lock	<ul style="list-style-type: none"> • Non-DEHP Formulation 	0.4 mL	8" (20 cm)	25	
MX448A 50351688507486	Small Bore Extension with Detachable Injection Site, Removable Blue Slide Clamp, Male Luer Lock	<ul style="list-style-type: none"> • Non-DEHP Formulation Fluid Path 	0.3 mL	7" (18 cm)	50	
MX448HL 50351688507448	ULTRA™ Small Bore Extension, Removable Slide Clamp, Male Luer Lock	<ul style="list-style-type: none"> • Non-DEHP Formulation • Lipid Resistant • Non-PVC 	0.3 mL	7" (18 cm)	50	
MX448L 50351688507400	Small Bore Extension with Removable Blue Slide Clamp, Male Luer Lock	<ul style="list-style-type: none"> • Non-DEHP Formulation 	0.3 mL	7" (18 cm)	50	
MX448HL36 50351688507431	ULTRA™ Small Bore Extension with Removable Slide Clamp, Male Luer Lock	<ul style="list-style-type: none"> • Non-DEHP Formulation • Lipid Resistant • Non-PVC 	1.1 mL	37" (94 cm)	50	

Please note: These products are not made with natural rubber latex.

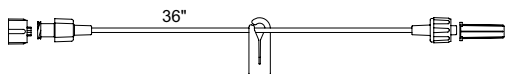
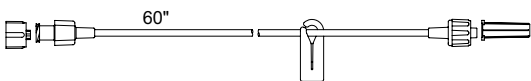
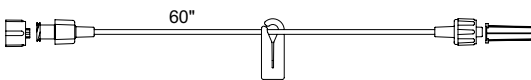
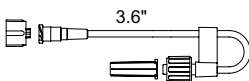
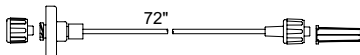
ORDERING INFORMATION

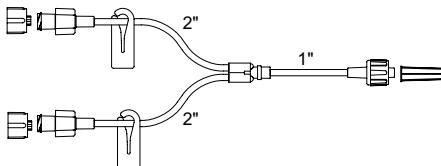
Small Bore					
Product Code	Description	Features	Approx Priming Volume	Approx Overall Length	Units Per Case
MX448L36 50351688507394	Small Bore Extension Removable Blue Slide Clamp, Male Luer Lock	<ul style="list-style-type: none"> • Non-DEHP Formulation 	1.0 mL	36" (91 cm)	50
					
MX448HL60 50351688507424	ULTRA™ Small Bore Extension with Removable Slide Clamp, Male Luer Lock	<ul style="list-style-type: none"> • Non-DEHP Formulation • Lipid Resistant • Non-PVC 	1.7 mL	60" (152 cm)	50
					
MX448L60 50351688507387	Small Bore Extension with Removable Blue Slide Clamp, Male Luer Lock	<ul style="list-style-type: none"> • Non-DEHP Formulation 	1.8 mL	60" (152 cm)	50
					
MX457L 50351688507097	Small Bore Extension with Swivel Male Luer Lock	<ul style="list-style-type: none"> • Non-DEHP Formulation 	0.3 mL	4" (10 cm)	50
					
MX580 50351688506403	Small Bore Tamper Resistant Extension with Male Luer Lock	<ul style="list-style-type: none"> • DEHP Formulation 	1.2 mL	70" (178 cm)	50
					
MX581 50351688506397	Small Bore Anti-Reflex Extension with Back Check Valve, Detachable Injection Site, Male Luer Lock	<ul style="list-style-type: none"> • DEHP Formulation 	0.5 mL	7" (18 cm)	50
					
MX612H 50351688506311	ULTRA™ Small Bore Bifurcated Extension with Removable Slide Clamps, Male Luer Lock	<ul style="list-style-type: none"> • Non-DEHP Formulation • Latex-Free • Lipid Resistant • Non-PVC 	0.4 mL	4" (10 cm)	50
					

Please note: These products are not made with natural rubber latex.

ORDERING INFORMATION

Small Bore					
Product Code	Description	Features	Approx Priming Volume	Approx Overall Length	Units Per Case
MX613H 50351688506298	ULTRA™ Small Bore Trifurcated Extension with Removable Slide Clamps, Male Luer Lock	<ul style="list-style-type: none"> • Non-DEHP Formulation • Lipid Resistant • Non-PVC 	5.0 mL	4" (10 cm)	50

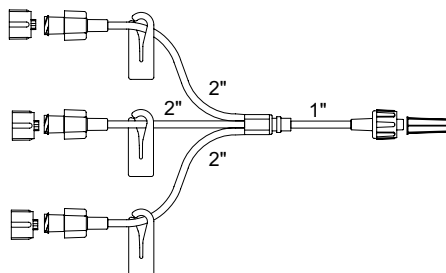

QF140 50351688500784	Small Bore Quad Extension with Non-Removable Blue Slide Clamps, 2 Non-Vented White Caps, Male Luer Lock	<ul style="list-style-type: none"> • Non-DEHP Formulation 	0.6 mL	7" (18 cm)	25
-------------------------	---	--	--------	------------	----

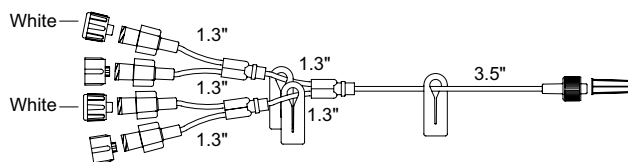

Please note: These products are not made with natural rubber latex.

ORDERING INFORMATION

Small Bore					
Product Code	Description	Features	Approx Priming Volume	Approx Overall Length	Units Per Case
SM5001 50351688500678	Small Bore Extension with SmartSite® Needle-Free Valve, Non-Removable Blue Slide Clamp, Slide Swivel Luer Lock	• Non-DEHP Formulation	0.3 mL	9" (23 cm)	100
SM5002 50351688500661	Small Bore Extension with SmartSite® Needle-Free Valve, Non-Removable Blue Slide Clamp, Male Luer Lock	• Non-DEHP Formulation	0.3 mL	8" (20 cm)	100
SM5003 50351688500654	Small Bore Bifurcated Extension, 2 SmartSite® Needle-Free Valves, Non-Removable Blue Slide Clamps, Male Luer Lock	• Non-DEHP Formulation	0.4 mL	5" (13 cm)	50
SM5004 50351688500647	Small Bore Extension with SmartSite® Needle-Free Valve, Swivel Male Luer Lock	• Non-DEHP Formulation	0.3 mL	6" (15 cm)	100
SM5014 50351688500555	Small Bore Trifurcated Extension with Non-Removable Blue Slide Clamps, 3 SmartSite® Needle-Free Valves, Male Luer Lock	• Non-DEHP Formulation	0.7 mL	5" (13 cm)	100
TF55 50351688500319	Small Bore Trifurcated Extension, 2 Non-Vented White Caps, Color-Coded Pinch Clamps, Male Luer Lock	• DEHP Formulation	0.8 mL	7" (18 cm)	25

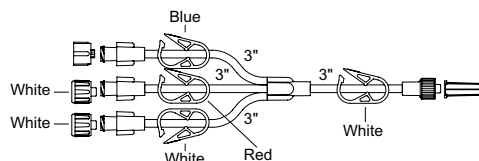

Please note: These products are not made with natural rubber latex.

ORDERING INFORMATION

Small Bore					
Product Code	Description	Features	Approx Priming Volume	Approx Overall Length	Units Per Case
TF56 50351688500302	Small Bore Trifurcated Extension, 2 Non-Vented White Caps, Color-Coded Pinch Clamps, Male Luer Lock	<ul style="list-style-type: none"> • Non-DEHP Formulation 	0.6 mL	9" (23 cm)	25

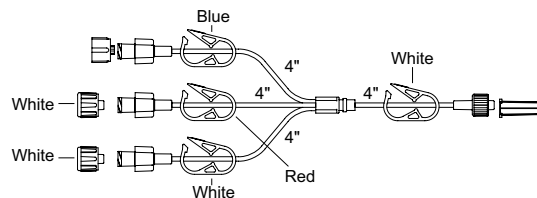

BBF26 50351688512015	Small Bore Extension, 1 Back Check Valve, Non-Removable Blue Slide Clamps, Swivel Male Luer Lock	<ul style="list-style-type: none"> • Non-DEHP Formulation 	0.3 mL	5" (13 cm)	25
-------------------------	--	--	--------	------------	----

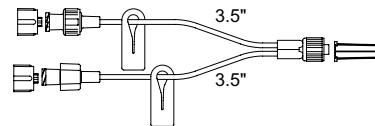

Small Bore Light Resistant Tubing					
Product Code	Description	Features	Approx Priming Volume	Approx Overall Length	Units Per Case
537235PS 50351688516280	Small Bore Light Resistant Extension, Non-Removable Blue Slide Clamp, Male Luer Lock	<ul style="list-style-type: none"> • Non-DEHP Formulation Fluid Path • Polyethylene Lined Tubing 	1.3 mL	72" (183 cm)	50

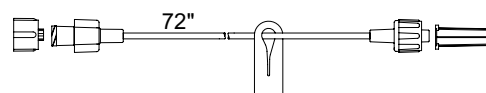

Small Bore T-Connectors					
Product Code	Description	Features	Approx Priming Volume	Approx Overall Length	Units Per Case
MX453H2L 50351688507202	ULTRA™ Small Bore Bifurcated T-Connector Extension with Injection Site, Removable Slide Clamps, Swivel Male Luer Lock	<ul style="list-style-type: none"> • Non-DEHP Formulation • Lipid resistant • Non-PVC 	0.5 mL	5" (13 cm)	50

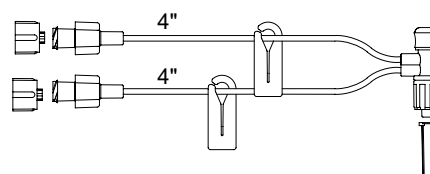

Please note: These products are not made with natural rubber latex.

ORDERING INFORMATION

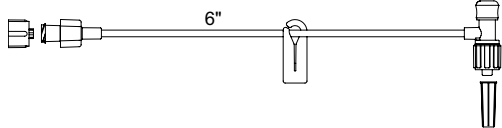
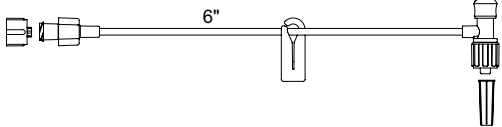
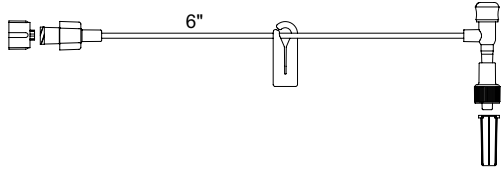
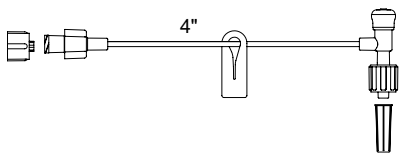
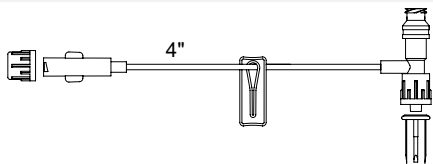
Small Bore T-Connectors					
Product Code	Description	Features	Approx Priming Volume	Approx Overall Length	Units Per Case
MX453HL 50351688507196	ULTRA™ Small Bore T-Connector with Injection Site, Removable Slide Clamp, Swivel Male Luer Lock	<ul style="list-style-type: none"> • Non-DEHP Fluid Path Formulation • Lipid resistant • Non-PVC 	0.4 mL	7" (18 cm)	50
					
MX453SL 50351688507172	Small Bore T-Connector with Injection Site, Removable BlueSlide Clamp, Swivel Male Luer	<ul style="list-style-type: none"> • Non-DEHP Formulation Fluid Path 	0.4 mL	7" (18 cm)	50
					
MX453L 50351688507189	Small Bore T-Connector Extension, Removable Blue Slide Clamp, Male Luer Lock	<ul style="list-style-type: none"> • Non-DEHP Formulation Fluid Path 	0.4 mL	7" (18 cm)	50
					
MX459SL 50351688507059	Small Bore T-Connector with Injection Site, Non-Removable Slide Clamp, Swivel Male Luer	<ul style="list-style-type: none"> • Non-DEHP Formulation Fluid Path 	0.3 mL	5" (13 cm)	50
					
SM5008 50351688500609	Small Bore T-Connector Extension with SmartSite® Needle-Free Valve, Non-Removable Slide Clamp, Swivel Luer Lock	<ul style="list-style-type: none"> • Non-DEHP Formulation 	0.2 mL	5" (13 cm)	100
					

Please note: These products are not made with natural rubber latex.

ORDERING INFORMATION

Small Bore T-Connectors					
Product Code	Description	Features	Approx Priming Volume	Approx Overall Length	Units Per Case
BBF26DTL 50351688512008	Small Bore Bifurcated T-Connector Extension with Injection Site, 1 Back Check Valve, Non-Removable Blue Slide Clamps, Swivel Male Luer	<ul style="list-style-type: none"> Non-DEHP Formulation Fluid Path 	0.4 mL	4" (10 cm)	25

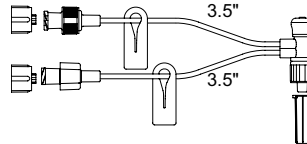

BTF36DTL 50351688511599	Small Bore Trifurcated T-Connector Extension with Injection Site, 2 Back Check Valves, Non-Removable Blue Slide Clamps, Swivel Male Luer	<ul style="list-style-type: none"> Non-DEHP Formulation Fluid Path 	0.4 mL	4" (10 cm)	25
----------------------------	--	---	--------	------------	----

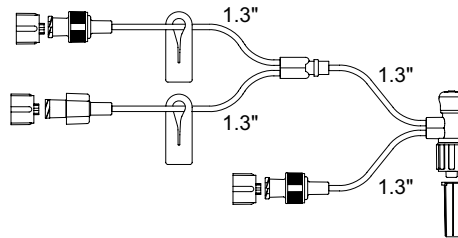

MBF27DTL 50351688510462	Small Bore Bifurcated T-Connector Extension with Injection Site, Blue Slide Clamps, Non-Vented White Cap, Swivel Male Luer	<ul style="list-style-type: none"> Non-DEHP Formulation Fluid Path 	0.4 mL	4" (10 cm)	25
----------------------------	--	---	--------	------------	----

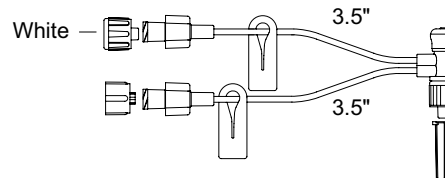

MBF29DTL 50351688510455	Small Bore Bifurcated T-Connector Extension, Color-Coded Pinch Clamps, Female Port, 2 Non-Vented White Caps, Swivel Luer Lock	<ul style="list-style-type: none"> Non-DEHP Formulation 	0.4 mL	4" (10 cm)	25
----------------------------	---	--	--------	------------	----

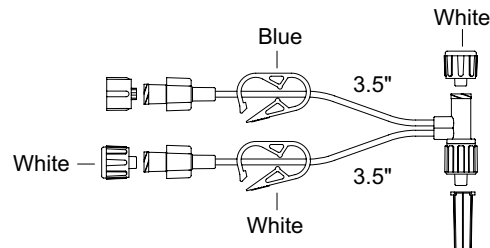

ORDERING INFORMATION

Small Bore T-Connectors					
Product Code	Description	Features	Approx Priming Volume	Approx Overall Length	Units Per Case
MTF37DTL 50351688510318	Small Bore Trifurcated T-Connector Extension with Injection Site, Non-Removable Blue Slide Clamps, 2 Non-Vented White Caps, Swivel Male Luer	<ul style="list-style-type: none"> Non-DEHP Formulation Fluid Path 	0.5 mL	4" (10 cm)	25

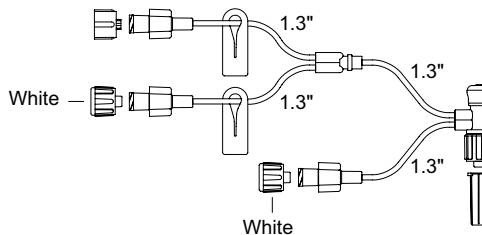

Micro Bore					
Product Code	Description	Features	Approx Priming Volume	Approx Overall Length	Units Per Case
533640 50351688516426	Micro Bore Extension with Male Luer Lock	<ul style="list-style-type: none"> Non-DEHP Formulation 	0.2 mL	37" (94 cm)	50

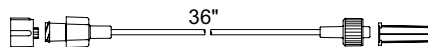

533640C 50351688516419	Micro Bore Extension with Male Luer Lock, Non-Removable Slide Clamp	<ul style="list-style-type: none"> Non-DEHP Formulation 		36" (91 cm)	50
---------------------------	---	--	--	-------------	----

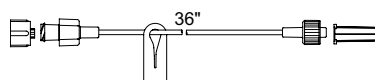

536020 50351688516396	Micro Bore Extension with Non-Removable Green Slide Clamp, Male Luer Lock	<ul style="list-style-type: none"> Non-DEHP Formulation 	0.4 mL	60" (152 cm)	50
--------------------------	---	--	--------	--------------	----

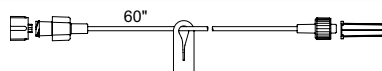

536040 50351688516334	Micro Bore Extension with Male Luer Lock	<ul style="list-style-type: none"> Non-DEHP Formulation 	0.3 mL	61" (155 cm)	50
--------------------------	--	--	--------	--------------	----

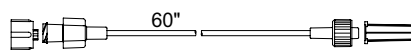

536040C 50351688516327	Micro Bore Extension with Non-Removable Slide Clamp, Male Luer Lock	<ul style="list-style-type: none"> Non-DEHP Formulation 	0.3 mL	61" (155 cm)	50
---------------------------	---	--	--------	--------------	----

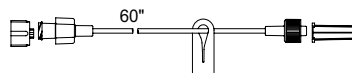

537220 50351688516310	Micro Bore Extension with Non-Removable Green Slide Clamp, Male Luer Lock	<ul style="list-style-type: none"> Non-DEHP Formulation 	0.5 mL	72" (183 cm)	50
--------------------------	---	--	--------	--------------	----

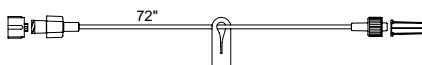

Please note: These products are not made with natural rubber latex.

ORDERING INFORMATION

Micro Bore					
Product Code	Description	Features	Approx Priming Volume	Approx Overall Length	Units Per Case
FS116 50351688510967	Micro Bore Extension with 0.2 Micron Filter, Non-Removable Blue Slide Clamp, Male Luer Lock	<ul style="list-style-type: none"> • Non-DEHP Formulation • Low Protein Binding Filter 	0.7 mL	62" (157 cm)	25

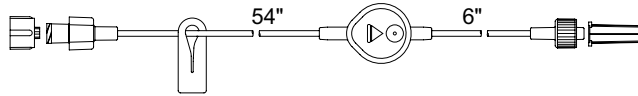

FS117 50351688510950	Micro Bore Extension with 0.2 Micron Filter, Non-Removable Blue Slide Clamp, "Y" Injection Site, Male Luer Lock	<ul style="list-style-type: none"> • Non-DEHP Fluid Path Formulation • Low Protein Binding Filter 	0.5 mL	8" (20 cm)	25
-------------------------	---	---	--------	------------	----

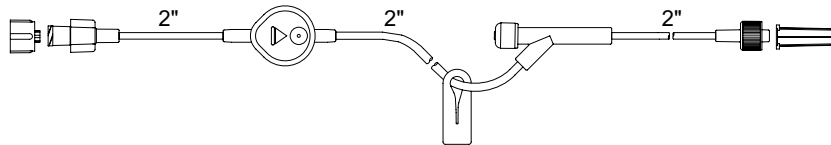

Micro Bore Light Resistant Tubing					
Product Code	Description	Features	Approx Priming Volume	Approx Overall Length	Units Per Case
537240PS 50351688516273	Micro Bore Light Resistant Extension, Male Luer Lock	<ul style="list-style-type: none"> • Non-DEHP Formulation Fluid Path • Polyethylene Lined Brown Tubing 	0.3 mL	72" (157 cm)	50

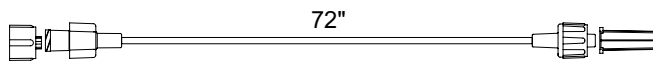

Non-PVC ULTRA™ Small Bore Extensions Sets

ORDERING INFORMATION

ULTRA™ Small Bore Extensions					
Product Code	Description	Features	Approx Priming Volume	Approx Overall Length	Units Per Case
MX448HF 50351688507462	ULTRA™ Small Bore Extension with 0.2 Micron Filter and Removable Slide Clamp, Male Luer Lock	<ul style="list-style-type: none"> • Non-DEHP formulation • Air Eliminating Filter • Lipid Resistant • Non-PVC • Low Protein Binding Filter 	1.0 mL	7" (18 cm)	50

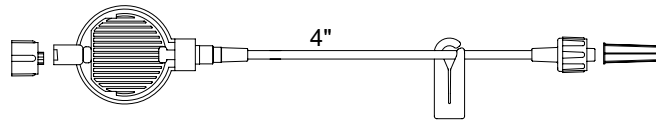

MX448HFB 50351688507455	ULTRA™ Small Bore Extension with 1.2 Micron Filter and Removable Slide Clamp, Male Luer Lock	<ul style="list-style-type: none"> • Non-DEHP formulation • Air Eliminating Filter • Lipid Resistant • Non-PVC • Low Protein Binding Filter 	1.0 mL	7" (18 cm)	50
----------------------------	--	--	--------	------------	----

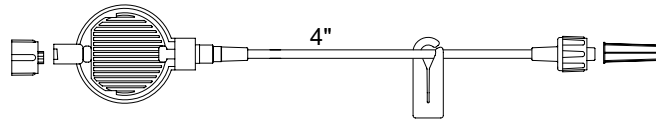

MX448HL 50351688507448	ULTRA™ Small Bore Extension, Removable Slide Clamp, Male Luer Lock	<ul style="list-style-type: none"> • Non-DEHP Formulation Fluid Path • Lipid Resistant • Non-PVC 	3.0 mL	7" (18 cm)	50
---------------------------	--	---	--------	------------	----

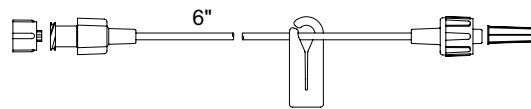

MX448HL36 50351688507431	ULTRA™ Small Bore Extension with Removable Slide Clamp, Male Luer Lock	<ul style="list-style-type: none"> • Non-DEHP Formulation Fluid Path • Lipid Resistant • Non-PVC 	1.1 mL	37" (94 cm)	50
-----------------------------	--	---	--------	-------------	----

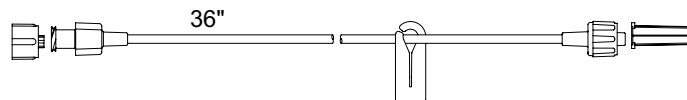

Please note: These products are not made with natural rubber latex.

ORDERING INFORMATION

Micro Bore					
Product Code	Description	Features	Approx Priming Volume	Approx Overall Length	Units Per Case
MX448HL60 50351688507424	ULTRA™ Small Bore Extension with Removable Slide Clamp, Male Luer Lock	<ul style="list-style-type: none"> • Non-DEHP Formulation • Lipid Resistant • Non-PVC 	1.7 mL	60" (152 cm)	50

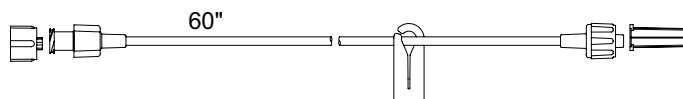

MX612H 50351688506311	ULTRA™ Small Bore Bifurcated Extension with Removable Slide Clamps, Male Luer Lock	<ul style="list-style-type: none"> • Non-DEHP Formulation • Lipid Resistant • Non-PVC 	0.4 mL	4" (10 cm)	50
--------------------------	--	--	--------	------------	----

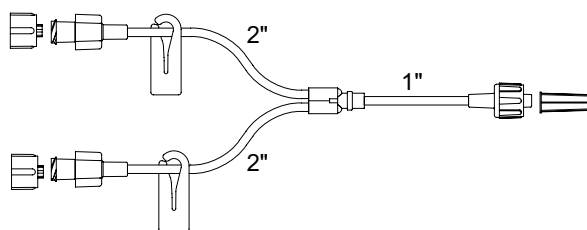

MX613H 50351688506298	ULTRA™ Small Bore Trifurcated Extension with Removable Slide Clamps, Male Luer Lock	<ul style="list-style-type: none"> • Non-DEHP Formulation • Lipid Resistant • Non-PVC 	0.5 mL	4" (10 cm)	50
--------------------------	---	--	--------	------------	----

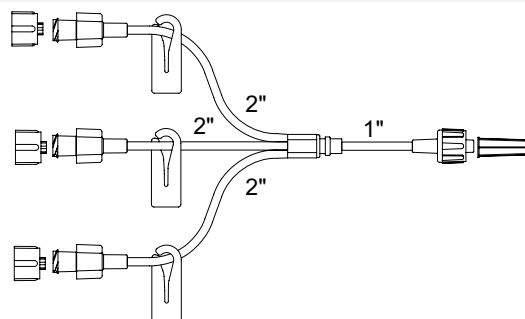

MX453H2L 50351688507202	ULTRA™ Small Bore Bifurcated T-Connector Extension with Injection Site, Removable Slide Clamps, Swivel Male Luer Lock	<ul style="list-style-type: none"> • Non-DEHP Fluid Path Formulation • Lipid Resistant • Non-PVC 	0.5 mL	5" (13 cm)	50
----------------------------	---	---	--------	------------	----

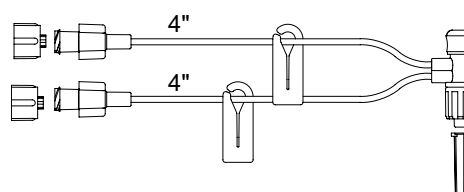

Please note: These products are not made with natural rubber latex.

ORDERING INFORMATION

Micro Bore					
Product Code	Description	Features	Approx Priming Volume	Approx Overall Length	Units Per Case
MX453HL 50351688507196	ULTRA™ Small Bore T-Connector with Injection Site, Removable Slide Clamp, Swivel Male Luer Lock	<ul style="list-style-type: none"> • Non-DEHP Formulation • Lipid Resistant • Non-PVC 	0.4 mL	7" (18 cm)	50

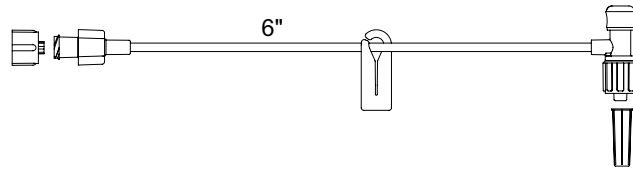

Filter Sets



ORDERING INFORMATION

ULTRA™ Small Bore Filter Sets					
Product Code	Description	Features	Approx Priming Volume	Approx Overall Length	Units Per Case
MX448HF 50351688507462	ULTRA™ Small Bore Extension with 0.2 Micron Filter and Removable Slide Clamp, Male Luer Lock	<ul style="list-style-type: none"> • Non-DEHP formulation • Lipid Resistant • Non-PVC • Low Protein Binding Filter • Air Eliminating Filter 	1.0 mL	7" (18 cm)	50

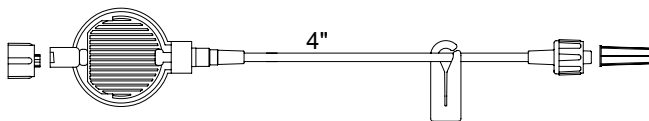

MX448HFB 50351688507455	ULTRA™ Small Bore Extension with 1.2 Micron Filter and Removable Slide Clamp, Male Luer Lock	<ul style="list-style-type: none"> • Non-DEHP formulation • Lipid Resistant • Non-PVC • Low Protein Binding Filter • Air Eliminating Filter 	1.0 mL	7" (18 cm)	50
----------------------------	--	--	--------	------------	----

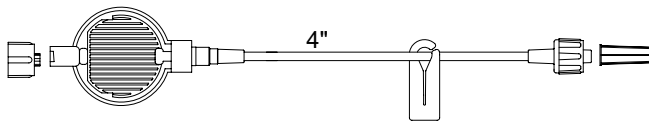

Filter Sets					
Product Code	Description	Features	Approx Priming Volume	Approx Overall Length	Units Per Case
FS113 50351688510981	Small Bore Trifurcated Extension with 0.2 Micron Filter, Color-Coded Non-Removable Slide Clamps, Male Luer Lock	<ul style="list-style-type: none"> • Non-DEHP formulation • Low Protein Binding Filter 	0.9 mL	13" (33 cm)	25

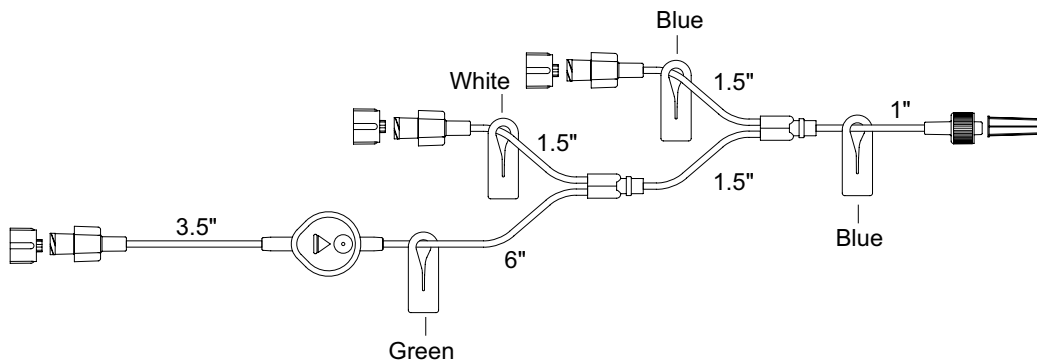

Please note: These products are not made with natural rubber latex.

ORDERING INFORMATION

Filter Sets					
Product Code	Description	Features	Approx Priming Volume	Approx Overall Length	Units Per Case
FS116 50351688510967	Micro Bore Extension with 0.2 Micron Filter, Non-Removable Blue Slide Clamp, Male Luer Lock	<ul style="list-style-type: none"> • Non-DEHP Formulation • Low Protein Binding Filter 	0.7 mL	62" (157 cm)	25

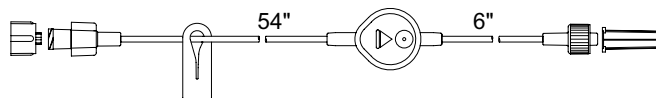

FS117 50351688510950	Micro Bore Extension with 0.2 Micron Filter, Non-Removable Blue Slide Clamp, "Y" Injection Site, Male Luer Lock	<ul style="list-style-type: none"> • Non-DEHP Formulation • Low Protein Binding Filter 	0.5 mL	6" (20 cm)	25
-------------------------	---	--	--------	------------	----

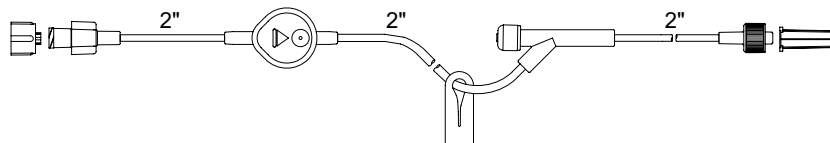

MX448FMG 50351688507479	Vented / Non-Vented Spike Mangum™ Micro Delivery Administration Set, Pinch Clamp, Back Check Valve, Anti Free-Flow Stopcock, 60" Small Bore Extension, 6" Detachable Extension, 0.2 Micron Filter, Male Luer Lock	<ul style="list-style-type: none"> • Non-DEHP Formulation • Low Protein Binding Filter 	3.0 mL	74" (188 cm)	25
----------------------------	---	--	--------	--------------	----

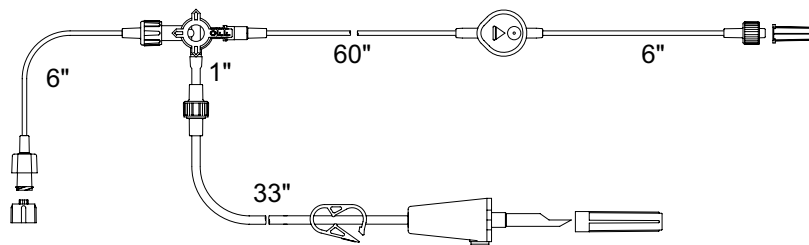

SM5020 50351688500548	Standard Bore Extension with 0.2 Micron Filter, Pinch Clamp, SmartSite® Needle-Free Valve, Slide Swivel Luer Lock	<ul style="list-style-type: none"> • Non-DEHP Formulation • Low Protein Binding Filter • Air Eliminating Filter 	3.1 mL	20" (51 cm)	25
--------------------------	---	--	--------	-------------	----

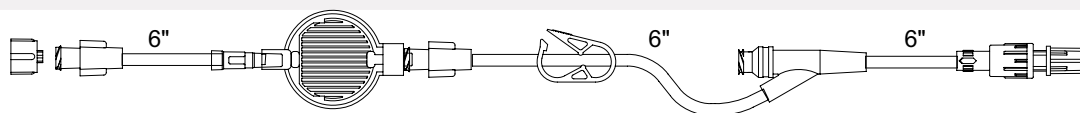

SM5021 50351688500531	Standard Bore Extension with 1.2 Micron Filter, Pinch Clamp, SmartSite® Needle-Free Valve, Slide Swivel Luer Lock	<ul style="list-style-type: none"> • Non-DEHP Formulation • Low Protein Binding Filter • Air Eliminating Filter 	3.0 mL	20" (51 cm)	25
--------------------------	---	--	--------	-------------	----

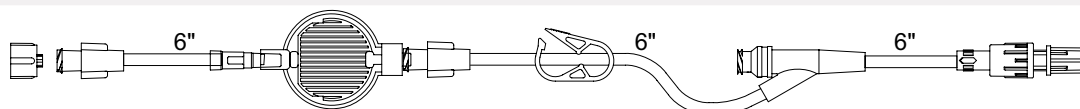

Please note: These products are not made with natural rubber latex.

Stopcocks



ORDERING INFORMATION

Small Bore

Product Code	Description	Features	Units Per Case
MX2311L 50351688508339	3-Way Stopcock with Swivel, Male Luer Lock	<ul style="list-style-type: none"> • Non-DEHP Formulation • Lipid Resistant • Non-PVC • 45 PSI Rated 	50

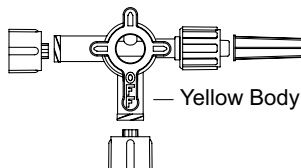

MX2341L 50351688508322	4-Way Stopcock with Swivel Male Luer Lock, Non-Vented Blue Cap on Middle Port	<ul style="list-style-type: none"> • Non-DEHP Formulation • Lipid Resistant • Non-PVC • 45 PSI Rated 	50
---------------------------	---	--	----

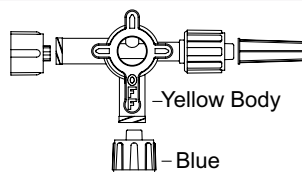

MX5061L 50351688506847	1-Way Stopcock with Swivel Male Luer Lock	<ul style="list-style-type: none"> • Non-DEHP Formulation • Lipid Resistant • Non-PVC • 45 PSI Rated 	50
---------------------------	---	--	----

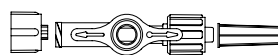

MX5311L 50351688506793	3-Way Stopcock with Swivel Male Luer Lock	<ul style="list-style-type: none"> • Non-DEHP Formulation • Lipid Resistant • Non-PVC • 45 PSI Rated 	50
---------------------------	---	--	----

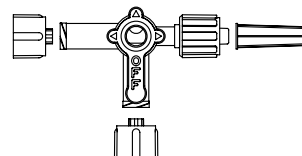

MX5341L 50351688508322	4-Way Stopcock with Swivel Male Luer Lock	<ul style="list-style-type: none"> • Non-DEHP Formulation • Lipid Resistant • Non-PVC • 45 PSI Rated 	50
---------------------------	---	--	----

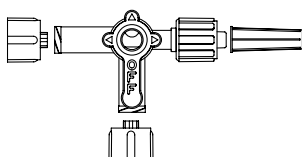

Please note: These products are not made with natural rubber latex.

ORDERING INFORMATION

Small Bore			
Product Code	Description	Features	Units Per Case
MX5341LN 50351688506779	4-Way Stopcock, Swivel Male Luer Lock, Non-Vented Red Cap on Middle Port	<ul style="list-style-type: none"> • Non-DEHP Formulation • Lipid Resistant • Non-PVC • 45 PSI Rated 	50

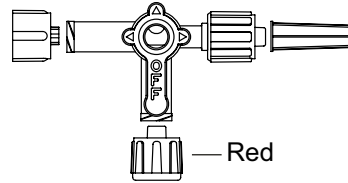

MX5342L 50351688506762	2-Gang, 4-Way Stopcock with Swivel Male Luer Lock	<ul style="list-style-type: none"> • Non-DEHP Formulation • Lipid Resistant • Non-PVC • 45 PSI Rated 	25
---------------------------	---	--	----

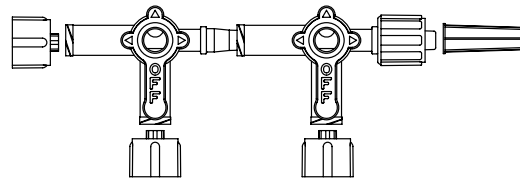

Large Bore - HI-FLO™			
Product Code	Description	Features	Units Per Case
MX4312L 50351688507752	2-Gang, 3-Way HI-FLO™ Stopcock with Extended Male Luer Lock	<ul style="list-style-type: none"> • Non-DEHP Formulation • Lipid Resistant • Non-PVC • 20 PSI Rated 	25

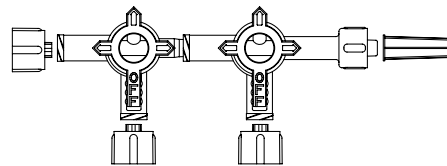

MX4313L 50351688507721	3-Gang, 3-Way HI-FLO™ Stopcock with Extended Male Luer Lock	<ul style="list-style-type: none"> • Non-DEHP Formulation • Lipid Resistant • Non-PVC • 20 PSI Rated 	25
---------------------------	---	--	----

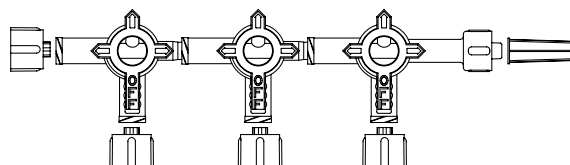

Please note: These products are not made with natural rubber latex.

ORDERING INFORMATION

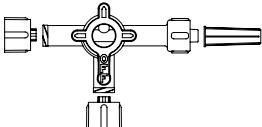
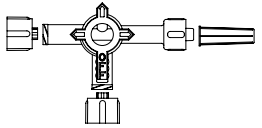
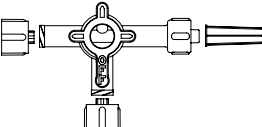
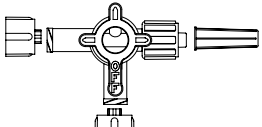
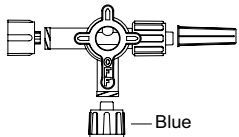
Large Bore - HI-FLO™			
Product Code	Description	Features	Units Per Case
MX4311L 50351688507769	3-Way HI-FLO™ Stopcock with Extended Male Luer Lock	<ul style="list-style-type: none"> • Non-DEHP Formulation • Lipid Resistant • Non-PVC • 45 PSI Rated 	50
			
MX4341L 50351688507646	4-Way HI-FLO™ Stopcock with Extended Male Luer Lock	<ul style="list-style-type: none"> • Non-DEHP Formulation • Lipid Resistant • Non-PVC • 45 PSI Rated 	50
			
MX434B1L 50351688507585	4-Way HI-FLO™ Stopcock with Blue Handle, Extended Male Luer Lock	<ul style="list-style-type: none"> • Non-DEHP Formulation • Lipid Resistant • Non-PVC • 45 PSI Rated 	50
			
MX9311L 50351688504188	3-Way HI-FLO™ Stopcock with Swivel Male Luer Lock	<ul style="list-style-type: none"> • Non-DEHP Formulation • Lipid Resistant • Non-PVC • 45 PSI Rated • Yellow Handle 	50
			
MX9341L 50351688504171	4-Way HI-FLO™ Stopcock with Swivel Male Luer Lock, Non-Vented Blue Cap on Middle Port	<ul style="list-style-type: none"> • Non-DEHP Formulation • Lipid Resistant • Non-PVC • 45 PSI Rated • Yellow Handle 	50
			

Please note: These products are not made with natural rubber latex.

ORDERING INFORMATION

Large Bore - HI-FLO™			
Product Code	Description	Features	Units Per Case
MX9342L 50351688504164	2-Gang, 4-Way HI-FLO™ Stopcock with Swivel Male Luer Lock	<ul style="list-style-type: none"> • Non-DEHP Formulation • Lipid Resistant • Non-PVC • 20 PSI Rated • Yellow Handle 	25

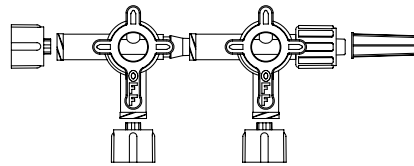

MX4342LM 50351688507639	2-Gang, 4-Way HI-FLO™ Stopcock Manifold, Extended Male Luer Lock	<ul style="list-style-type: none"> • Non-DEHP Formulation • Lipid Resistant • Non-PVC • 20 PSI Rated 	25
----------------------------	--	--	----

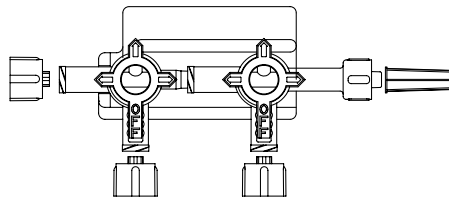

MX934Z3LM 50351688504157	3-Gang, 4-Way HI-FLO™ Stopcock Manifold with Swivel Male Luer Lock, Non-Vented Blue Caps on Middle Ports	<ul style="list-style-type: none"> • Non-DEHP Formulation • Lipid Resistant • Non-PVC • 20 PSI Rated • Yellow Handles 	20
-----------------------------	--	--	----

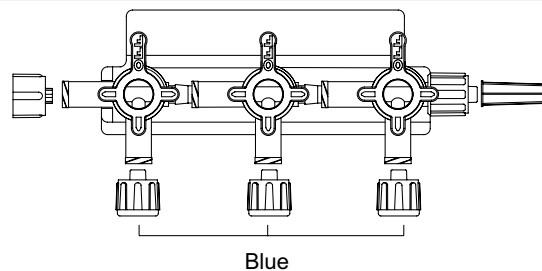

MX4343LM 50351688507615	3-Gang, 4-Way HI-FLO™ Stopcock Manifold, Extended Male Luer Lock	<ul style="list-style-type: none"> • Non-DEHP Formulation • Latex-Free • Lipid Resistant • Non-PVC • 20 PSI Rated 	20
----------------------------	--	--	----

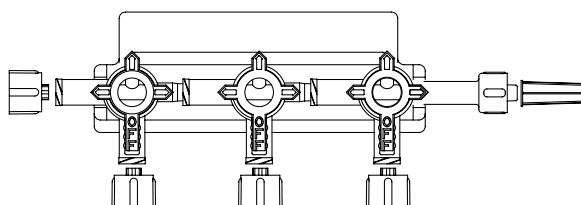

Please note: These products are not made with natural rubber latex.

ORDERING INFORMATION

Large Bore - HI-FLO™			
Product Code	Description	Features	Units Per Case
MX934Z4LM 50351688504140	4-Gang, 4-Way HI-FLO™ Stopcock Manifold with Swivel Male Luer Lock, Non-Vented Blue Caps on Middle Ports	<ul style="list-style-type: none"> • Non-DEHP Formulation • Lipid Resistant • Non-PVC • 20 PSI Rated • Yellow Handle 	20

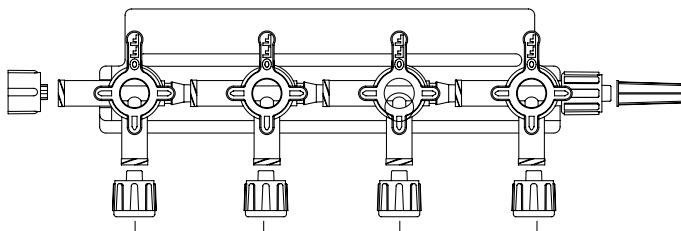

Blue

MX4345LM 50351688507592	5-Gang, 4-Way HI-FLO™ Stopcock Manifold, Extended Male Luer Lock	<ul style="list-style-type: none"> • Non-DEHP Formulation • Lipid Resistant • Non-PVC • 20 PSI Rated 	10
----------------------------	--	--	----

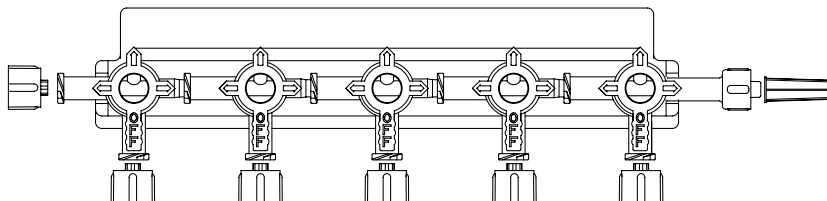

Components

ORDERING INFORMATION



Check valves

Product Code	Description	Features	Approx Priming Volume	Approx Overall Length	Units Per Case
MX745 50351688505406	Mini Duckbill Back Check Valve with Male Luer Lock	<ul style="list-style-type: none"> • Non-DEHP Formulation • Non-PVC 	0.1 mL	1" (3 cm)	100



Connectors

Product Code	Description	Features	Approx Priming Volume	Approx Overall Length	Units Per Case
MX301 50351688508049	5 in 1 Connector, Fits 7/32" Diameter to 7/16" Diameter Tubing, Non-Sterile (Autoclavable)	<ul style="list-style-type: none"> • Non-DEHP Formulation • Non-PVC 	N/A	3" (8 cm)	200 (50/bag)



MX493 50351688506915	Double Male Luer Lock Adapter	<ul style="list-style-type: none"> • Non-DEHP Formulation • Lipid Resistant • Non-PVC 	0.1 mL	1" (3 cm)	100
-------------------------	-------------------------------	--	--------	-----------	-----

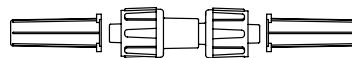

MX494 50351688506908	Double Female Luer Lock Adapter	<ul style="list-style-type: none"> • Non-DEHP Formulation • Lipid Resistant • Non-PVC 	0.2 mL	2" (5 cm)	100
-------------------------	---------------------------------	--	--------	-----------	-----

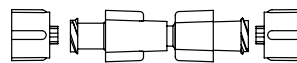

Please note: These products are not made with natural rubber latex.

ORDERING INFORMATION

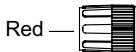
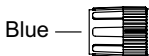
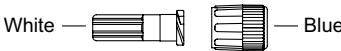
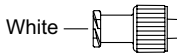
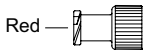
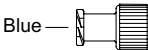
Caps					
Product Code	Description	Features	Units Per Case		
MX49001 50351688506984	Female Port Cap, Red	<ul style="list-style-type: none"> • Non-DEHP Formulation • Non-PVC 	100		
MX49002 50351688506977	Female Port Cap, Blue	<ul style="list-style-type: none"> • Non-DEHP Formulation • Non-PVC 	100		
MX490C 50351688506960	Luer Lock Caps for Male and Female Ports, Sold Connected	<ul style="list-style-type: none"> • Non-DEHP Formulation • Non-PVC 	100		
MX491 50351688506953	Dual Function White Luer Lock Cap for Male and Female Ports	<ul style="list-style-type: none"> • Non-DEHP Formulation • Non-PVC 	100		
MX49101 50351688506946	Dual Function Red Luer Lock Cap for Male and Female Ports	<ul style="list-style-type: none"> • Non-DEHP Formulation • Non-PVC 	100		
MX491B 50351688506939	Dual Function Blue Luer Lock Cap for Male and Female Ports	<ul style="list-style-type: none"> • Non-DEHP Formulation • Non-PVC 	100		

1-Way Valve Medifolds					
Product Code	Description	Features	Approx Priming Volume	Approx Overall Length	Units Per Case
MX708 50351688505611	2-Port Medifold with High Cracking Pressure Back Check Valves on Each Port, Vented Green Caps on Middle Ports, Male Luer Lock	<ul style="list-style-type: none"> • Non-DEHP Formulation 	1.3 mL	3" (8 cm)	25

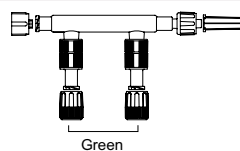

Please note: These products are not made with natural rubber latex.

ORDERING INFORMATION

1-Way Medifolds

Product Code	Description	Features	Approx Priming Volume	Approx Overall Length	Units Per Case
MX7083CV 50351688505604	3-Port Medifold with High Cracking Pressure Back Check Valves on Each Port, Vented Green Caps on Middle Ports and In-Line Back Check Valve, Male Luer Lock	• Non-DEHP Formulation	2.4 mL	6" (15 cm)	25

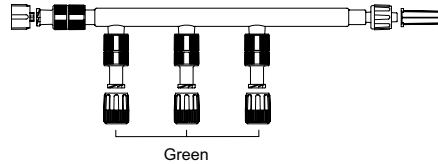

MX709 50351688505598	4-Port Medifold with High Cracking Pressure Back Check Valves on Each Port, Vented Green Caps on Middle Ports, Male Luer Lock	• Non-DEHP formulation	2.6 mL	6" (15 cm)	25
-------------------------	---	------------------------	--------	------------	----

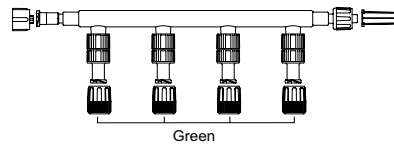

Injection Sites

Product Code	Description	Features	Approx Priming Volume	Approx Overall Length	Units Per Case
MX492 50351688506922	Injection Site with Male Luer Lock	• Non-DEHP Formulation Fluid Path	0.1 mL	1" (3 cm)	100

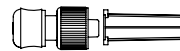

MX498 50351688506878	Injection Site with Male Luer Lock	• Non-DEHP Formulation Fluid Path	0.2 mL	1.5" (4 cm)	100
-------------------------	------------------------------------	-----------------------------------	--------	-------------	-----

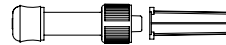

460000 50351688516471	Injection Site with Male Luer Lock	• Non-DEHP Formulation Fluid Path	0.2 mL	1.5" (4 cm)	200
--------------------------	------------------------------------	-----------------------------------	--------	-------------	-----



MX701 50351688505697	"W" Site with 2 Detachable Injection Sites, Female Luer Lock, Swivel Male Luer Lock	• Non-DEHP Formulation Fluid Path	0.8 mL	1" (3 cm)	25
-------------------------	---	-----------------------------------	--------	-----------	----

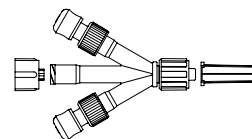

ORDERING INFORMATION

Needle-Free Access Systems					
Product Code	Description	Features	Approx Priming Volume	Approx Overall Length	Units Per Case
SM5000 50351688500685	SmartSite® Needle-Free Valve with Male Luer Lock	<ul style="list-style-type: none"> • Non-DEHP Formulation Fluid Path • Non-PVC 	0.1 mL	1" (3 cm)	100

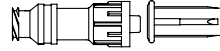

SM701 50351688500494	"W" Site with 2 Detachable SmartSite® Needle-Free Valves, Female Luer Lock, Swivel Male Luer Lock	<ul style="list-style-type: none"> • Non-DEHP Formulation • Latex-Free 	0.9 mL	2.5" (6.3 cm)	100
-------------------------	---	--	--------	---------------	-----

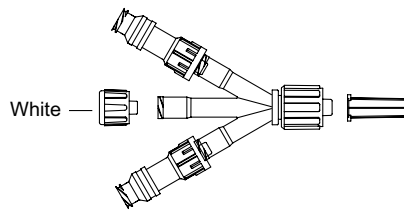

Please note: These products are not made with natural rubber latex.

Index

NUMBERS

53035	15
460000	39
533640	25
533640C	25
536020	25
536035	15
536035SC	16
536040	25
536040C	25
537220	25
537235C	16
537235PS	22
537240PS	26
539635	16
5360225	15
5360225C	15

B

BBF26	22
BBF26DTL	24
BF13	16
BF100	16
BTF36	16
BTF36DTL	24

F

FS113	17 30
FS116	26 31
FS117	26 31

M

MBF27	17
MBF29DTL	24
MBF30	17
MTF37	17
MTF37DTL	25
MX048	9
MX252L	9
MX253L	9
MX254	10
MX301	37
MX412SL	10
MX413SL	10
MX422SL	10
MX423L	10

MX423YSL	11
MX434B1L	34
MX448A	18
MX448FMG	7 31
MX448HF	27 30
MX448HFB	27 30
MX448HL	18 27
MX448HL36	18 27
MX448HL60	19
MX448HLMG	7 8
MX448L	18
MX448L36	19
MX448L60	19
MX448L60MG	7
MX450FL	11
MX450SL	11
MX451FL	11
MX451SL	11
MX452	11
MX452FL	11
MX453H2L	22 28
MX453HL	23 29
MX453L	23
MX453SL	23
MX454FL	11
MX455FL	12
MX456CVL	12
MX456L	12 13
MX456R	12
MX457L	19
MX458L	12
MX459SL	23
MX490C	38
MX491	38
MX491B	38
MX492	39
MX493	37
MX494	37
MX498	39
MX522L	13
MX522SL	13
MX580	19
MX581	19
MX612H	19 28
MX613H	20 28

MX701	39
MX708	38
MX709	39
MX743	37
MX821L	4
MX821S	4
MX934Z3LM	35
MX934Z4LM	36
MX2311L	32
MX2341L	32
MX4233NS	10
MX4311L	34
MX4312L	33
MX4313L	33
MX4341L	34
MX4342LM	35
MX4343LM	35
MX4345LM	36
MX5061L	32
MX5311L	32
MX5341LN	33
MX5342L	33
MX7083CV	39
MX7222SC	13
MX7322SC	4 6
MX9311L	34
MX9341L	34
MX9342L	35
MX20194	17
MX20307R1	9
MX43660	18
MX43661	18
MX43860	18
MX49001	38
MX49002	38
MX49101	38
MX5096020MG	8

Q

QF140	20
-------	----

S

SM701	40
SM872M	4
SM873	6
SM924SL	15

SM5000	40
SM5001	21
SM5002	21
SM5003	21
SM5004	21
SM5006	13
SM5008	23
SM5010	14
SM5011	14
SM5012	14
SM5014	21
SM5020	14 31
SM5021	14 31
SM5024	14
SM7223SC	15
SM90976	6

T

TF55	21
TF56	22

For more information visit our website at www.smiths-medical.com
or call Customer Service at 1-800-258-5361

PRODUCT(S) DESCRIBED MAY NOT BE LICENSED OR AVAILABLE FOR SALE IN CANADA AND OTHER COUNTRIES

Smiths Medical ASD, Inc.
6000 Nathan Lane North
Minneapolis, MN 55442, USA
Phone: 1-614-210-7300
Toll-Free USA: 1-800-258-5361
www.smiths-medical.com

Find your local contact information at: www.smiths-medical.com/customer-support

Smiths Medical is part of the global technology business Smiths Group plc. Please see the Instructions for Use/Operator's Manual for a complete listing of the indications, contraindications, warnings and precautions. Mangum, Medex, Hi-flo and the Smiths Medical design mark are trademarks of Smiths Medical. The symbol ® indicates the trademark is registered in the U.S. Patent and Trademark Office and certain other countries. All other names and marks mentioned are the trademarks or service marks of their respective owners. ©2017 Smiths Medical. All rights reserved. SM190005EN-032017

MDBLCA-1025

Rx
ONLY
smiths medical